

REV.	ECH NO	LOCATIONS	DESCRIPTION	DATE	REVSER	APPD
REV	ECHNO	LOCATIONS	DESCRIPTION	DATE	REMSER	

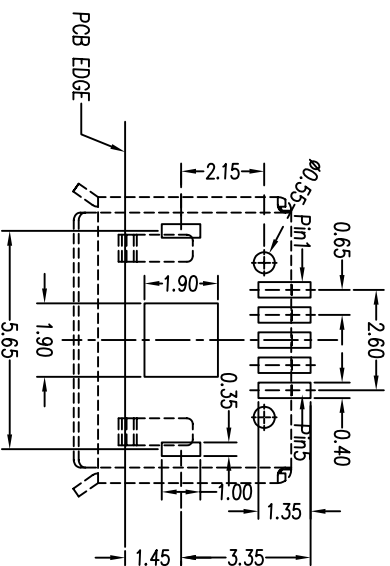
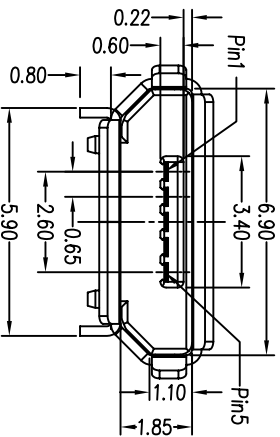
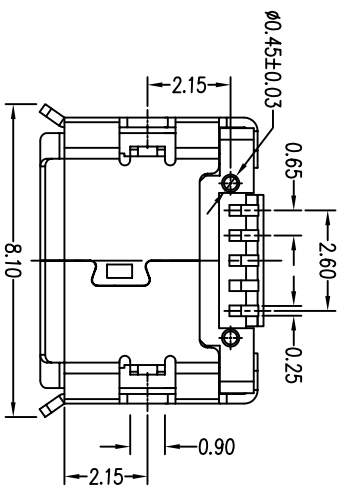
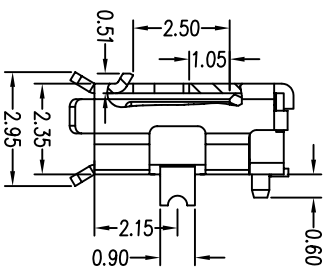
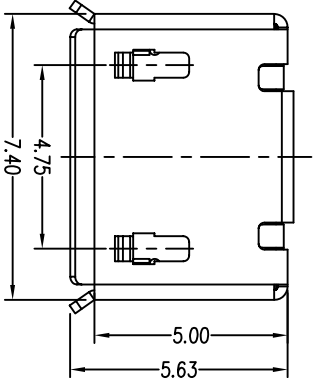
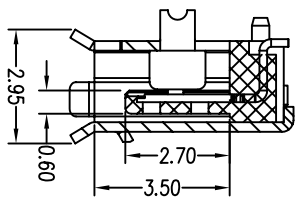
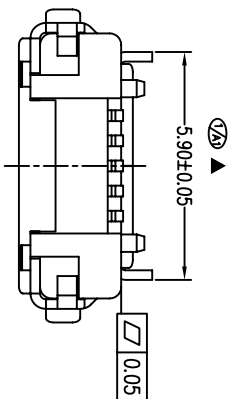

RECOMMENDED PCB LAYOUT

Note:

- Material:
 - Housing: High temperature thermoplastic with g.f. UL94V-0
 - Contact: copper alloy, t=0.20mm
 - Shell: copper alloy, t=0.25mm
- Specification:
 - Current rating: 1 A Max.
 - Dielectric withstanding voltage: 100 V(ac) for 1 min.
 - Contact resistance: 50 mΩ Max.
 - Insulation resistance: 100 MΩ Min.
 - Total mating force: 3.57 Kgf Max.
 - Total unmating force: 1.0 Kgf Min. 0.81~2.05 Kgf Min. after 10000 insertion/extraction cycles
 - Temperature range: -30°C~80°C

Order Information:

1-MD05SMXXX-01

- | | | | |
|----------------|-----------|--------------------|------------------|
| 1: Assy. | 5: Style | 7: Contact plating | 8: Shell plating |
| 2: Series No. | M: Smt | 1: 1u" | T: Tin |
| 3: Contact No. | 6: Color | 2: 3u" | N: Nickel |
| 05: 5 pos. | B: Black | 3: 5u" | A: Au plated all |
| 4: P: Plug | W: White | 4: 15u" | B: None |
| S: Socket | N: Nature | 5: 30u" | ... |

PART NO.	PARTNO.	MATERIAL	MATERIAL
MODEL NO:	MOLDNO.	FINSH:	FINISH
UNIT:	UNIT	COLOR:	COLOR
TOLERANCE UNSPECIFIED	SIZE:	DR:	??BR
.X	.XX	CHK:	
.XX	.XXX	APP:	
ANG.	ANG.		

NO.	Shell	Contact	Housing	Q'ty	Finish
1	1	5	1	1	N/A
2	1	1	1	1	N/A
3	1	1	1	1	N/A

UNIT	UNIT	SIZE	SIZE	COLOR	COLOR
.X	.XX	.X	.XX		
.XX	.XXX	.XX	.XXX		
ANG.	ANG.				

深圳市德瑞电子有限公司
SHENZHEN DERUI ELECTRONIC CO., LTD.

Micro usb 5s B Type Smt 插板式

SCALE	SCALE	SHEET	SHEET	REV	REV